

Substation Lighting

Design Standard

DOCUMENT HIERARCHY

This document resides within the Planning component of Western Power’s Asset Management System (AMS).

DOCUMENT DATE

This document was last updated February 2024

IMPLEMENTATION DATE

This document came into service June 2013

DOCUMENT CONTROL

Record of endorsement, approval, stakeholders, and notification list is provided in EDM# 34233757 appendix

RESPONSIBILITIES

Western Power’s Engineering & Design Function is responsible for this document

CONTACT

Western Power welcomes your comments, questions, and feedback on this document, which can be emailed to standards.excellence@westernpower.com.au

DISCLAIMER

This document is published by Western Power for information purposes only. The user must make and rely on their own inquiries as to the quality, currency, accuracy, completeness, and fitness for purpose of any information contained in this document. Western Power does not give any warranty or make any representation concerning the information provided in this document. By using the information in this document, the user acknowledges that they are solely responsible for obtaining independent professional advice prior to commencing any project, activities, or other works. Western Power is not liable in any way for any loss, damage, liability, cost or claim of any kind whatsoever (including responsibility by reason of its negligence) arising from or in connection with the use of or reliance on the information contained in this document. Western Power reserves its rights to modify, supplement or cancel this document or any part thereof at any time and without notice to users.

COPYRIGHT

© Copyright 2024 Electricity Networks Corporation trading as Western Power. All rights reserved. No part of this work may be reproduced or copied in any form or by any means without the written permission of Western Power or unless permitted under the Copyright Act 1968 (Cth). Product or company names are trademarks or registered trademarks of their respective holders

© Western Power
ABN 18540492861



Contents

CONTENTS	2
REVISION DETAILS	4
1 INTRODUCTION	5
1.1 PURPOSE AND SCOPE	5
1.2 ACRONYMS	5
1.3 DEFINITIONS.....	5
1.4 REFERENCES.....	6
2 SUPPORTING DOCUMENTATION	6
3 COMPLIANCE	6
4 FUNCTIONAL REQUIREMENTS	7
5 SAFETY IN DESIGN	7
6 OVERVIEW OF THE MAIN DESIGN ELEMENTS	8
7 PURPOSE OF SUBSTATION LIGHTING	8
7.1 PERIPHERY AREA.....	8
7.2 ORIENTATION AREA.....	9
7.3 SWITCHING POINT AREA.....	9
7.4 SWITCH/RELAY ROOMS.....	9
7.5 SECURITY.....	9
8 REQUIRED LIGHTING LEVELS	9
8.1 GENERAL ACCESS	9
8.2 SECURITY.....	10
8.3 OBTRUSIVE LIGHT.....	10
9 LAMP TYPE	10
9.1 RECOMMENDED LAMP TYPE.....	10
9.2 HISTORICALLY USED LAMPS.....	11
9.3 DESIGN PARAMETERS.....	11
10 LIGHT FITTING TYPE	12
11 LIGHT FIXING POINT	13
12 SUPPLY AND CONTROL	14
13 EMERGENCY LIGHTING	15
14 MODELLING	15
15 PRODUCT SOURCING	16
16 DOCUMENTATION REQUIRED	16
17 DRAWINGS	16
18 COMMISSIONING	16
APPENDIX A: DERIVATION OF REQUIRED LUX LEVELS	18
APPENDIX B: LIGHT FITTINGS	19
APPENDIX C: TYPICAL LIGHTING MODELS	30
APPENDIX D: APPROVAL RECORD AND DOCUMENT CONTROL	41

Revision Details

Version	Date	EDM Version	Summary of change
0	14/06/2013	0.3 (minor)	First Issue
1	09/08/2019	1	Integrated LED's, high level mast and updated to latest EDI template
1a	03/06/2020	2	Amended table 5 – New LED light fittings and recommended height added (page 14). Modified section 11 for brownfield applications (page 16) Added data sheets in Appendix B for 300W and 450W LED floodlight (page 20 & 21).
2	02/12/2021	3	Amended table 5 – LED light fittings for Switch and Relay rooms and basement changed to include an emergency light option. Updated Appendix B Light fitting details for room and basement lights Updated Appendix C.5 and C.6 with new model for LED lights. Section 11 updated to clarify the light installation height for switch and relay rooms and to state that grout is no longer to be installed on lighting masts. Section 13 updated with standard references and paragraph on emergency work lighting added.
3	January 2024	4	Standards Online Update

1 Introduction

Adequate lighting is required during low light conditions.

The main objective for zone and terminal substation lighting at WP is to ensure:

- Adequate working conditions
- Safe movement of traffic
- Safe movement of vehicles
- Safe identification of plant and equipment
- Safety and security of people and property

This Engineering Design Instruction specifies the lighting requirements for Western Power greenfield zone and terminal substations.

1.1 Purpose and scope

The purpose of this document is to specify the requirements for lighting within Western Power's zone and terminal substations and provide guidance for the designers on this topic. This Engineering Design Instruction outlines the lux levels required for different areas within the substation and states the approved lamp and fitting types to be used. The designer uses these requirements and reference examples and during the lighting design for a site.

1.2 Acronyms

Acronym	Definition

1.3 Definitions

Term	Definition
CCT – Correlated Colour Temperature	The specification of the colour appearance of the light emitted by a lamp, relating its colour to the colour of light from a reference source when heated to a particular temperature, measured in Kelvin (K).
CFL – Compact Fluorescent Lamp CFT – Compact Fluorescent Tube	A fluorescent lamp designed to replace an incandescent lamp. The lamps use a tube which is curved or folded to fit into the space of an incandescent bulb, and a compact electronic ballast in the base of the lamp.
CMH – Ceramic Metal Halide Lamp	A variation of a metal halide lamp, which itself is a variation of the old high pressure mercury vapour lamp. The discharge is contained in a ceramic tube. The tube is filled with mercury, argon and metal halide salts. The high temperature inside the tube causes the metal halide salts to be partly vaporised. This causes a hot plasma inside the tube causing salts to be dissociated into metallic atoms and iodine. The metallic atoms are the main source of the light, allowing lamps to create a bluish light that is similar to daylight.

Fluorescent Lamp	A gas discharge lamp that uses electricity to excite mercury vapour. The excited mercury atoms produce short-wave ultraviolet light that then causes phosphor to fluoresce, producing visible light.
HID – High Intensity Discharge Lamp	A type of electrical gas discharge lamp which produces light by means of an electric arc between tungsten electrodes housed inside a translucent arc tube. The tube is filled with both gas and metal salts. The gas facilitates the arc’s initial strike. Once the arc is started, it heats and evaporates the metal salts forming a plasma, which greatly increases the intensity of light produced. HID Lamps can include HPS and Metal Halide.
HPS – High Pressure Sodium Lamp	A gas discharge lamp that uses sodium in an excited state to produce light. The colour discharge is yellow. “white” – refers to a colour improved HPS lamp which emits a white colour light. “colour improved” – refers to an improved colour rendering of a HPS lamp to contain less of a yellowish tinge.
Incandescent	An electric light which produces light with a filament wire heated to a high temperature by an electric current passing through it.
LED – Light Emitting Diode	A semiconductor light source that emit light when current flows through it. They are illuminated solely by electrons moving within a semiconductor releasing energy in the form of photons.
Lux	The SI unit for illuminance and luminous emittance, measuring luminous flux per unit area. One lux is equal to one lumen per square meter.
Metal Halide Lamp	An electric light that produces light by an electric arc through a gaseous mixture of vaporized mercury and metal halides (compounds of bromine or iodine).
Obtrusive Light	The unwanted light spilling from a lit area affecting both people and fauna.

1.4 References

References which support implementation of this document

Table 1.1 References

Reference No.	Title

2 Supporting Documentation¹

3 Compliance

The Engineering Design Instruction should encompass all requirements of the relevant Australian Standards which are current at the time. These relevant Australian Standards are listed in below in Table 3.1. A period

¹ See Western Power Internal Document

will be set when the standard needs to be reviewed. If significant changes occur on an Australian Standard which affects safety, then an out of cycle review can be completed.

Table 3.1: Australian Standards

Standard Number	Standard Title
CIE 129-1998	Commission Internationale de L' Eclairage - Guide for lighting exterior works areas
CIE S 015/E:2005	Commission Internationale de L' Eclairage - Lighting of Outdoor Work Places
AS 4282:2019	Control of the obtrusive effects of outdoor lighting
AS1158.3.1 – 2015	Lighting for roads and public spaces
AS1680.0 – 2009	Interior Lighting – Safe movement
AS 60079:14 – 2013	Explosive Atmospheres - Part 14: Design selection, erection and initial inspection
AS 3011.1 - 1992	Electrical Installations – Secondary batteries installed in buildings
AS 3000 - 2018	Electrical Installations – Wiring rules
AS 2293.1	Emergency Lighting and Exit Signs for Buildings Part 1: System Design Installation and Operation
AS 2293.3	Emergency Lighting and Exit Signs for Buildings Part 3: Emergency Luminaires and Exit Signs

4 Functional Requirements

This Engineering Design Instruction is intended to be used by Substation Engineering staff and by companies completing outsourced design work for Western Power, as it outlines the Western Power requirements pertaining to lighting design.

5 Safety in Design²

Safety in Design (SID) must be considered when completing all substation design work. SID focuses on making the design safer and easier to understand, with the aim to eliminate and mitigate potential hazards during the design phase of a project.

Some examples of Safety in Design in lighting design include:

- Potential trip hazards – are the lights providing adequate visibility for main access areas.
- Light switch position – Are light switches installed in a practical position, away from potential hazards (e.g. electrical equipment, drop offs)?
- Maintenance of lights – Can the lights be changed without an outage whilst maintaining electrical safety clearance?
- Illuminance levels – Is there enough visibility to perform the required task (identifying circuits, control room switching etc.)?

² See Western Power Internal Document

- Location of lights in switchroom basements – any risk of damage to the light due to low installation height?
- Use single pole RCBO to avoid tripping all lights circuits for a fault
- Potential nuisance to adjacent properties

All projects are required to have a SID Hazard Register to include evidence of all measures implemented to eliminate or reduce risks.

6 Overview of the Main Design Elements³

Standard light fittings and lamps identified in Section 9 and 10 shall be used for all greenfield applications and brownfield sites whenever possible. Standard layout and drawings showing proposed lighting locations and orientation are to be used as reference only. Each substation will be unique with the size and electrical configurations which will require site specific lighting studies to satisfy the lux level requirements outlined in Section 8.

The supply and control of the lights must be installed as per the requirements set out in Section 12.

Lighting studies are to be conducted using AGi32 software with modelling details and design parameters outlined in Section 8 and 14.

7 Purpose of Substation Lighting

The purpose of yard lighting is to provide adequate lighting to contribute to the safety, performance of physical task and to provide an appropriate visual environment for safe access within the substation. For specific tasks (switching, construction, commissioning etc.), additional portable lighting will be required.

The requirement for lighting is determined by the area and functionality/security of the area which is being illuminated. To ensure that the lighting is concentrated in areas where it is required, the main considerations of the lighting design are;

- Periphery Area
- Orientation Area
- Switching Point Area
- Switch/Relay Rooms
- Security

These categories will each be discussed separately below as they have different requirements.

7.1 Periphery Area

The periphery area is close to the perimeter fence, away from all live electrical equipment such as busbars, line circuits, capacitor banks and transformers. The periphery is considered low risk, as the area contains no energised circuits or plant and therefore is electrically safe for pedestrian movement. Due to the low risk of

³ See Western Power Internal Document

this area, the recommended average lux level that must be maintained is 5. Note: This does not apply if the site requires additional security which is covered in Section 7.5.

7.2 Orientation Area

Orientation areas are where the live electrical equipment is located. These are areas such as line circuits, busbars, capacitor banks and transformer circuits. Since these areas contain live equipment, the average lux level that must be maintained is 20. This light level will be enough for people to orientate themselves and walk safely within the electrically energised areas. These areas are categorised as medium risk.

7.3 Switching Point Area

In terms of substation lighting, the switching points are the most important places within any zone or terminal yard. In the event of an emergency it is critical that these areas have enough light to allow people to identify which circuit they have to attend and the nearest isolation point. For this reason, it is required that these areas achieve an average illumination level of 50 lux. Portable lights will be necessary to supplement this light level if the operator is required to do more detailed work on the site, for example carry out switching or isolation work.

7.4 Switch/Relay Rooms

Adequate lighting for the switch and relay rooms are necessary as these rooms house the MV switchgear and protection/control equipment respectively. Since these rooms have no windows, there is no natural light provided. Adequate lighting needs to be provided to ensure people can operate equipment and work comfortably at all times of the day and night without straining their eyes. The required average illumination level for switch and relay rooms is 200 lux. Switchroom basements have a lower average illumination level requirement of 50 lux.

Lighting in switchroom basements are required to have a minimum rating of IK9 or to be installed with a protective cage to provide mechanical protection.

7.5 Security

For certain sites, additional security lighting may be required to increase personnel safety and reduce the incidence of vandalism and theft.

When required, security lighting is usually fitted around the perimeter of the zone or terminal substation in addition to the minimum prescribed lighting outlined in this EDI.

The requirement for security lighting is not standard and would need to be identified during the concept design stage of a project. This will be advised by the security advisor of Western Power.

8 Required Lighting Levels

8.1 General Access

In order to meet the lighting requirements discussed in Section 7, the lux levels in **Table 8.1** must be met for the different areas within the substation.

Table 8.1: Substation Required Average Lux Levels by Area

Area	Risk Level	Required Average Lux Levels
Perimeter Area	Low Risk	5
Orientation	Medium Risk	20
Switching Points	High Risk	50
Switch and Relay Rooms	High Risk	200
Switchroom Basement	High Risk	50

For justification of chosen required lux levels, see Appendix A.

8.2 Security

If security lighting is required, an average lux level of 7 shall be achieved for a distance of 1m outside the perimeter fence (as per AS1158.3.1:2005).

When switched on, the light must be instantaneous, without requiring any warm up time.

8.3 Obtrusive Light

For substations located within residential/industrial areas, only a certain amount of light may be spilled outside the substation boundary. This is to control the amount of unwanted light from the substation affecting both people and fauna.

The amount of light spilling outside a substation onto nearby dwellings, must comply with the maximum lux level indicated in **Table 8.2** below.

Table 8.2: Obtrusive Maximum Light Lux Levels (from AS 4282:1997)

Location	Maximum Lux Value	
	06:00 – 22:00	22:00-06:00
Residential Area	1	1
Mixed Use Area	3	1
CBD and Industrial Area	15	5

9 Lamp Type

9.1 Recommended Lamp Type⁴

Greenfield installations shall use light emitting diode (LED) lights. These lights are extremely energy efficient, long lasting and cost effective. LED's have a rugged design as they are made of solid material with no filament, tube or bulbs to break. These lights fire instantaneously and have excellent colour rendition properties, meaning that they allow colour identification and reduced glare and eye strain.

Appendix B contains catalogue items for recommended lamp types and fittings.

⁴ See Western Power Internal Document

Brownfield installations shall use LED lights when new lights are installed. These shall be modelled with the existing surrounding lights to ensure adequate lux levels are achieved. For lamp replacement on existing fittings the lamp (and/or fitting) shall be replaced with a LED-equivalent if practical.

For existing sites with generator supply, load banks should be considered where old lights were used as base loads. Internal glazing and carbon build up is due to prolonged periods of generators running at low loads. The LEDs consume significantly less energy and load banks may be required to prevent damage to any generators.

9.2 Historically used lamps⁵

9.3 Design Parameters

The choice of LED as the recommended lamp type in Section 9.1 has been based on the following lighting requirements:

- The selected lamp type must be easy to source for maintenance.
- Lamp type must have colour rating within 60 to 80, to ensure accurate colour detection.
- Lamp type must have a temperature between 4000 and 5000K.
 - Lamps within the 4000 – 5000K spectrum emit a white light that is not too harsh for the human eye. It does not cause stress on the eye when trying to focus and doesn't cause distortions or colour discrepancy.
 - Lamps with a value <4000K will provide a "warmer" colour and make things appear with a yellowish tinge. This can be problematic when it comes to distinguishing colours.
 - Lamps with a value >5000K appear "cooler" and make objects appear with a bluish tinge. It can also cause the eye to have trouble focusing on an object and at times can strain a person's eyes.

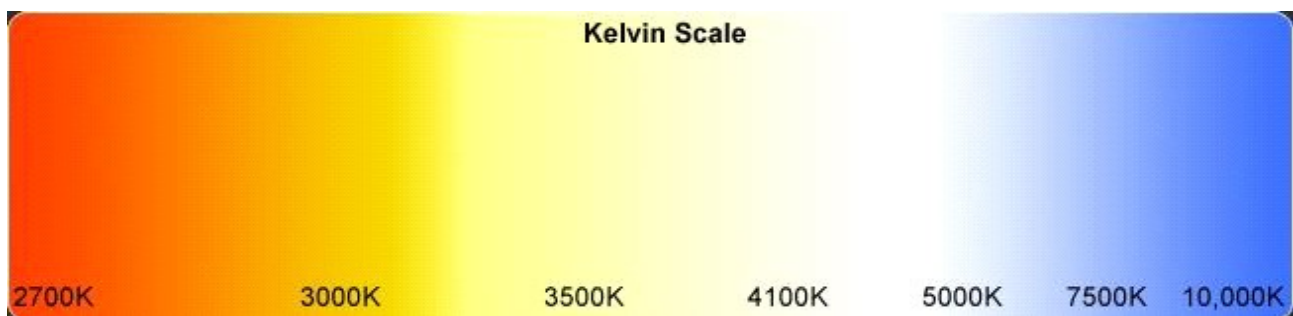

Figure 9.1: Kelvin Range showing Colour

- The whole of life cost of the lamp type must be considered (maintenance, initial unit cost etc.).
- For security lights – the lamp type chosen must have instantaneous firing capability. (I.e. light must output maximum capacity immediately after they are switched on).

⁵ See Western Power Internal Document

10 Light Fitting Type

Table 10.1 below recommends the lamp and fitting types to be used to comply with parameters in Sections 8 and 9. Data sheets and the relevant software models can be found in **Appendix B**. All lights installed on site shall meet the requirements of AS2293.1.

Table 10.1: Recommended light fittings and lamps to be used in Greenfield substations

Area	Lamp Type	Lamp	Lamp Manufacturer	Power Rating	Recommended height	Light Fitting	Light Fitting Manufacturer	Data Sheet (Fitting)	Model
Switchyard	LED	LED	Lumileds Luxeon	450W	12m, 15m	Luminant	PureLED	Appendix B	Luminant 450
Switchyard	LED	LED	Lumileds Luxeon	300W	12m, 15m	Luminant	PureLED	Appendix B	Luminant 300
Switchyard	LED	LED	Lumileds Luxeon	150W	6m	Luminant	PureLED	Appendix B	Luminant 150
Switchyard	LED	LED	Lumileds Luxeon	120W	6m	Luminant	PureLED	Appendix B	Luminant 120
Backup/Security	LED	LED	Philips	34w	-	CitySpirit Cone	Philips - Light Application	Appendix B	LACSCF7Z34
External Wall	LED	LED	Eye Lighting	28W	3m	Merican	Eye Lighting	Appendix B	203700
Switch and Relay Room	LED	LED	Clevertronics	46W	3m AFL (suspended)	Argonaut Vandal Resistant	Clevertronics	Appendix B	FVP4LED-P
Switch and Relay Room (Emergency)	LED	LED	Clevertronics	46W	3m AFL (suspended)	Argonaut Vandal Resistant	Clevertronics	Appendix B	LVP4LEDM-P
Switchroom Basement	LED	LED	Clevertronics	22W	1m AFL (wall mounted)	Argonaut Vandal Resistant	Clevertronics	Appendix B	FVP2LED-P
Switchroom Basement (Emergency)	LED	LED	Clevertronics	22W	1m AFL (wall mounted)	Argonaut Vandal Resistant	Clevertronics	Appendix B	LVP2LEDM-P

11 Light Fixing Point

All lights shall be fixed on lighting posts, on the walls of buildings, on boundary walls or on fire walls. Lights must not be fixed onto any other equipment or structure within the substation.

For yard lights the lighting posts shall be see-saw type and have a standard height of 6m for zone substations and 12m for terminal substations. Each lighting post shall be checked to ensure the see-saw mast does not breach electrical safety clearances when lowered for maintenance. Alternative lighting pole heights may be considered for specific sites that cannot meet this clearance due to space restrictions. In brownfield applications, new light installations (or replacements) may match existing lights if practical pending approval from Substation Design. Where security lighting is required near the boundary, low level posts shall be used with light types as listed in Table 10.1 above.

Lighting masts shall not be grouted at the base to alleviate the build up of water within the base of the structure.

Bulkheads fitted to the outside of switch rooms, relay rooms, boundary and fire walls shall be mounted at a height of 3m. These lights must be shown on the building lighting layout drawing. Bulkheads mounted outside switch room must stay clear from arc duct exit points, to allow for safe maintenance and replacement.

For the switch and relay room internal lighting, the light fittings shall be suspended from the ceiling at a height of 3m AFL (above floor level). In the switch room basement the light fittings shall be installed on the basement walls at a height of 1m AFL.

Mounting of luminaires shall consider the following requirements:

- Security and safe access to relay room(s)
- Reading of equipment labels or instruction and operational activities in the switchyard
- Visual impact to surrounding properties
- Standard safety clearances away from overhead conductors and other equipment shall be maintained at all times
- Shall not be installed on primary equipment or equipment structures
- Shall not be installed such that there is unwanted 'spill' and 'glare' at the boundary.

For greenfield sites, relay rooms no longer have a separate battery room. The information below remains to provide guidance for light replacements in existing battery rooms.

The design for the battery room lighting shall be in accordance with AS 3011.1 Section 2.2.6 which states battery luminaires shall be:

- Installed in accordance with AS 1680.1
- Installed in the middle of aisles
- A minimum clearance of 200mm from any part of a battery; and
- Luminaries shall not be installed directly over a cell or an exposed live part.

In addition, the battery room light fittings in the immediate vicinity of the main batteries shall comply with the following requirements:

- AS 60079:14 and AS 3000 for use in a Class 1 Zone 2 hazardous areas;
- IP 65 degree of protection in line with AS 1939 i.e. the fittings shall be industrial type with dust and vapour sealed construction

12 Supply and Control

Light switches must be installed near the main gates of all zone and terminal yards, as well as near the inside of entry doors of all switch and control rooms. The switches must be clearly labelled. All outdoor lights must also be controllable by a main outdoor lighting contactor, generally shown on the AC changeover board schematic drawing (see Figure 12.1).

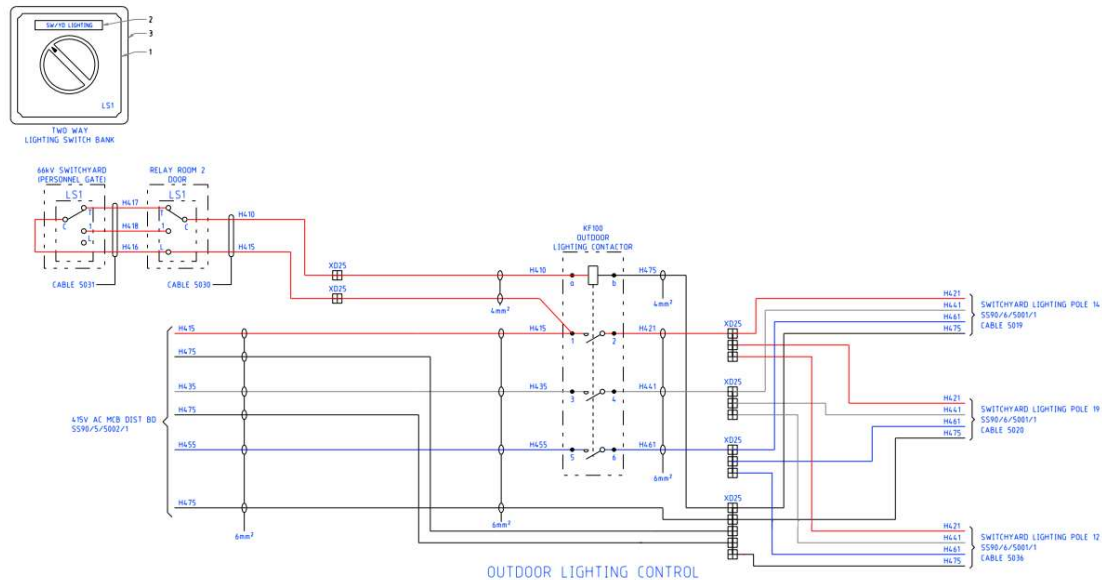

Figure 12.1: Example of outdoor lighting contactor schematic

Control switches, to enable the outdoor switchyard lighting to satisfactorily illuminate the switchyard at entry, shall be installed as follows:

- Zone substations
 - two way switching
 - inside the normally used access gate and
 - outside wall adjacent to the relay building entrance
- Terminal substations
 - two way switching
 - inside the normally used access gate(s) and
 - outside wall adjacent to the relay building(s) entrance
- A facility to remotely control the outdoor lighting contactors shall be provided for both zone and terminal substations:
 - Control voltage 24 VDC
 - Supplied to interface disconnect terminals

Control switches, to enable indoor lighting shall be fitted as follows:

- On the interior walls at each point of entry to a room;
- On the external walls of the battery room;
- Installed at minimum of 1100mm above the floor and 150mm away from doors; and
- Where appropriate have luminous markers to assist personnel to locate switches

Each light switch must be clearly labelled with its purpose, i.e. 'Indoor building lights' or 'Yard lights'.

Installation of 3 phase MCB's for multiple lighting circuits are to be avoided to ensure a single trip does not black out the entire yard. Outdoor lighting circuits are to be arranged to use single phase RCBO (Residual Current Circuit Breaker with Overcurrent Protection) installed for each circuit to provide segregation in the event of failure on a single circuit.

13 Emergency Lighting

Emergency lighting shall be installed in substation buildings to provide sufficient light such that personnel can navigate around the building in the event of an AC supply failure. The emergency lighting system shall be designed in accordance with the following standards:

- NCC - Class 8 building
- Emergency escape lighting - AS 2293.1-2018
- Emergency luminaires and exit signs - AS 2293.3-2018

The emergency light fittings shall preferably have a separate housing for the batteries to minimise the heat effects of the light on the battery. They shall operate from the mains AC supply and, in the event of mains failure, from internal batteries. These batteries shall have:

- have a minimum expected battery life of 5 years
- be subject to a continuous trickle charge while the normal AC supply is available to the fitting
- the ability to be replaced without having to replace the whole light fitting.

A test switch for the emergency lighting system must be installed and labelled 'Emergency Lighting Test Switch'. The MCBs supplying the switchroom and basement lighting shall have a label saying 'WARNING: INTERRUPTING SUPPLY WILL DISCHARGE EMERGENCY LIGHTING BATTERIES' to comply with AS 2293.1 Section 2.4. This sign must be installed on every device which if turned off will cause the emergency lighting/exit signs to operate. All emergency lights need to be affixed with the identification symbol for emergency luminaires and be labelled with a unique identifier number (not on removable cover) as per AS2293.1.

The emergency lighting system shall be modelled as per the requirements of Section 14. Appendix C contains example layouts showing the emergency lighting levels.

Battery room fittings should comply with AS/NZS 3000 for use in a Class 1 Zone 2 hazardous area, AS/NZS 60079.0:2019 and AS/NZS 60079.14:2017.

Safety signage shall be illuminated and labelled in accordance with AS 2293.3-2018.

Some buildings in brownfield sites have existing 'emergency work lighting' (or 'work lighting') systems supplied directly by the substation DC system (not by internal light fitting batteries). These emergency work lighting systems can be manually activated in the event of an AC supply loss. When lighting is upgraded at these sites, a study shall be completed to assess the emergency lighting requirements (to ensure compliance with the standards above), before the existing 'emergency work lighting' system can be removed. When removing old lighting systems, all associated control equipment shall also be removed.

14 Modelling⁶

The number and type of lamps and light fittings required in substation buildings and outdoor yards shall be determined by utilizing the appropriate lighting software.

⁶ See Western Power Internal Document

At Western Power, the standard lighting software “AGi32” is used to model and assess the lighting requirements of a substation. This software has the capability to do 3D rendering of the lights to take into account shadow effects and calculate the resultant lux level throughout the substation.

Software other than AGi32 must be approved for use by the Substation Design Area within Western Power before the lighting design is undertaken.

All lighting studies in native format are to be saved in EDM and referenced in the Lighting Design Report.

15 Product Sourcing

All lamps and lighting fittings recommended in this Engineering Design Instruction can be sourced via manufacturers detailed in Table 10.1 and Appendix B.

Non-standard lamps can be used, as long as the chosen lamp can provide similar lumen output, light distribution, power consumption, colour rendition properties and operate in the same colour temperature range as lamps specified in this Engineering Design Instruction while being readily available. Non-standard lamps and light fittings must be approved by the Substation Design Principal Electrical Design Engineer.

16 Documentation Required

The main output of the lighting design process is a Substation Lighting Design Report. This report shall document all decisions made with respect to the lighting design. The report shall also include screenshots of the simulated lighting models (AGi32) used to check average lux levels in the substation. See Appendix C for an example of the expected format.

The Lighting Design Report shall be referenced in the Substation Design Report and saved in EDM.

17 Drawings⁷

A lighting drawing shall be issued with the primary drawing package showing the location and type of all lighting.

18 Commissioning

Once design and construction of the substation lighting system is completed, a commissioning test should be completed to validate the lighting design.

The testing areas that need to be checked are listed in Table 18.1 below. Testing should be conducted during times when the capture of surrounding lights are minimised.

A suitable lux meter will be required and the name of the unit must be recorded at the time of testing. A minimum of 20 test points will be required for each area listed in Table 18.1 around the zone or terminal substation and must include all switching points. This is to ensure an average lux level can be determined.

⁷ See Western Power Internal Document

Table 18.1: Lighting Design Validation Checklist

Substation Lighting Validation				
Test Unit Used:				
Model Number:				
Number of Test Points (minimum 20)				
Area	Required Average Lux Levels	Design Lux Levels	Actual Lux Levels	
Perimeter Area	5			
Orientation	20			
Switching Points	50			
Switch and Relay Rooms	200			
Switchroom Basement	50			
Location	Maximum Lux Value		Design Lux Levels	Actual Lux Levels
Time of Test	06:00 – 22:00	22:00 – 06:00		
Residential Area	1	1		
Mixed Use Area	3	1		
CBD and Industrial Area	15	5		

Appendix A: Derivation of Required Lux Levels⁸

⁸ See Western Power Internal Document

Appendix B: Light Fittings



Luminant Modular418 – Floodlight

PL-LuminantModular418-K-C-B

The pureLED Luminant Modular floodlight range is a highly efficient and reliable IP66 LED floodlight ideally suited for Sports, Industrial and large area floodlighting applications. The asymmetrical distribution options provide excellent glare control and symmetric distributions are available where specifically required. Using high quality Lumileds LED's and Meanwell drivers you can be assured of the best performance over a long lifetime in a variety of environments. Drivers can be supplied onboard the floodlight or suitable for remote mounting and in fixed, Dali or 1-10v options. Using the pureLED Luminant Modular range you can be assured of a high quality lighting installation and result.



Part #	PL-LuminantModular418-K-C-B
Colour Temp: (K)	3000K, 4000K, 5700K
Control: (C)	Switching, DALI, or 0-10V Dimmable
Beam Angle: (B)	130°x25°, 130° x 40° asymmetric (symmetric options available on request)
Other Information	
IP rating:	IP66
Housing Colour:	Black
CRI:	>70
Wattage:	438-475W
Weight:	19.20Kg (Integral Driver) 14.41Kg (Head Only - Remote Driver)

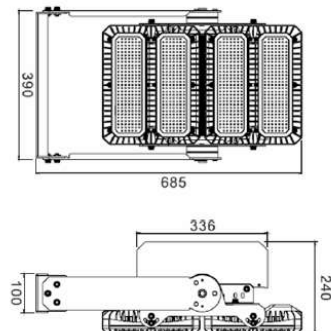



Luminant Modular417 – Floodlight

PL-LuminantModular417-K-C-B

The pureLED Luminant Modular floodlight range is a highly efficient and reliable IP66 LED floodlight ideally suited for Sports, Industrial and large area floodlighting applications. The asymmetrical distribution options provide excellent glare control and symmetric distributions are available where specifically required. Using high quality Lumileds LED's and Meanwell drivers you can be assured of the best performance over a long lifetime in a variety of environments. Drivers can be supplied onboard the floodlight or suitable for remote mounting and in fixed, Dali or 1-10v options. Using the pureLED Luminant Modular range you can be assured of a high quality lighting installation and result.



Part #	PL-LuminantModular417-K-C-B
Colour Temp: (K)	3000K, 4000K, 5700K
Control: (C)	Switching, DALI, or 0-10V Dimmable
Beam Angle: (B)	25°, 60° and 130° x 40° asymmetric
Other Information	
IP rating:	IP66
Housing Colour:	Black
CRI:	>70
Wattage:	267-292W
Weight:	9.2Kg

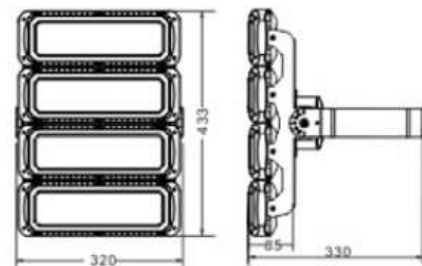



Luminant150 – Floodlight

PL-Luminant150 -K-C

The pureLED Luminant range of floodlights are a highly efficient and reliable IP66 asymmetrical LED floodlight suitable for a wide range of area floodlighting applications. Using high quality Lumileds Luxeon LED chips and Meanwell drivers you can be assured of the best performance over a long lifetime in a variety of environments. With DALI or 1-10v options also available the PureLED Luminant range has the flexibility to meet most general floodlighting requirements.



Part #	PL-Luminant150-K-C
Colour Temp: (K)	3000K, 4000K, 5700K
Control: (C)	Switching, DALI, or 0-10V Dimmable
Other Information	
IP rating:	IP66
Beam Angle:	90° x 40° asymmetric
Housing Colour:	Black
CRI:	>70
Wattage:	150W
Weight:	7.4kg

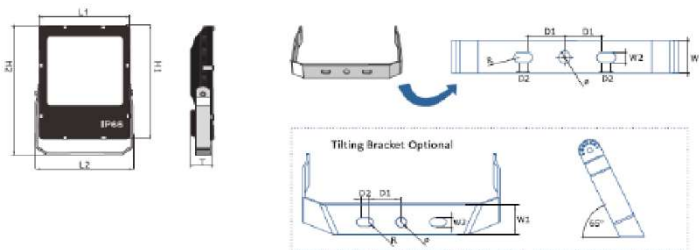
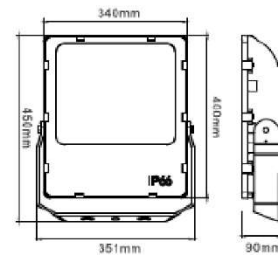

Power	H1	H2	L1	L2	T	D1	D2	W1	W2	R	Ø
100W-200W	440	450	340	360	90	48	40	55	13	6.5	13



Luminant120 – Floodlight

PL-Luminant120-K-C

The pureLED Luminant range of floodlights are a highly efficient and reliable IP66 asymmetrical LED floodlight suitable for a wide range of area floodlighting applications. Using high quality Lumileds Luxeon LED chips and Meanwell drivers you can be assured of the best performance over a long lifetime in a variety of environments. With DALI or 1-10v options also available the PureLED Luminant range has the flexibility to meet most general floodlighting requirements.



Part #	PL-Luminant120-K-C
Colour Temp: (K)	3000K, 4000K, 5700K
Control: (C)	Switching, DALI, or 0-10V Dimmable
Other Information	
IP rating:	IP66
Beam Angle:	90° x 40° asymmetric
Housing Colour:	Black
CRI:	>70
Wattage:	120W
Weight:	7.4kg

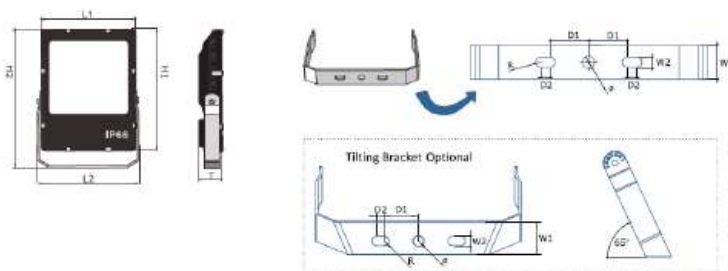
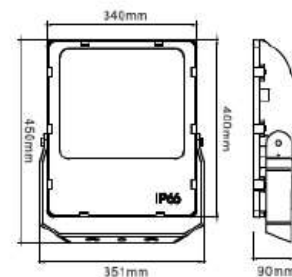

Power	H1	H2	L1	L2	T	D1	D2	W1	W2	R	Ø
100W-200W	440	450	340	360	90	48	40	55	13	6.5	13

Bright and beautiful streetscapes



Beautifully designed lighting adds heart and soul to any city. It enables public spaces to be well-lit and rightly lit, invigorating communities and making everyone feel safe and welcome.

Philips CitySpirit Cone is an energy-saving LED lighting solution that does not compromise on aesthetics. Its luminaire, mast, and bracket carry an integrated and stylish design that beautifully blends into any urban landscape. Various combinations of optical components generate lighting effects that meet different lighting requirements and ensure visual comfort at the right light level.

Available in two different color options, Philips CitySpirit Cone offers versatility, consistent light quality, and impressive energy efficiency.

Applications

- Parks, gardens, and promenades
- Shopping center plazas
- Sidewalks
- Residential areas

Good looking, good quality



Features and benefits

- **Good design.** Sleek and stylish, fits into any urban landscape.
- **Long-lasting.** Long lifetime of 50,000 hours.
- **Versatility.** Its symmetrical, asymmetrical and road configuration light distribution meet requirements of different lighting applications.

Product dimensions (Unit: mm)

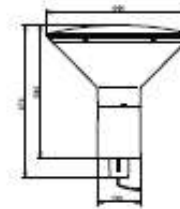

Light distribution curves

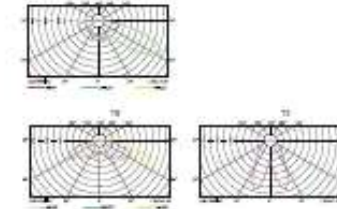

Take the Next Step

See how Philips CitySpirit Cone can address your roads and streets lighting needs. Contact your local Philips Sales Representative for more information or to schedule a personalized demonstration.

Product data

General Characteristics

Type	LACSC37Z
Lifetime	50,000 hours (70% lumen maintenance @ Ta = 35°C)
Optic	TS: Symmetrical TA: Asymmetrical TB: Road configuration

Mechanical

Product dimension	Ø640mm, H670mm
Material and finishing	UV-resistant transparent PC texture lampshade, high-pressure casting aluminium light body and upper cover
Weight	10kg
Housing body colour	Dark Grey (RAL7043)

Light Technical Characteristics

Lumen output	High lumen version: Natural white NW>4,000lm; low lumen version: Natural white NW>2,600lm
LED	Mid-Power LED
Light distribution	Landscape configuration (symmetrical or asymmetrical), road light distribution
Color rendering Index Ra	>70
SDCM	5

Product Data

Installation	Post top mounted, locked with 2xM8 hexagon screws. Recommended installation height is 4m, suitable for Ø60mm pole.
Classification	Class I, IP65, IK09
Operating temperature	-40°C ~ +50°C
Certification	CB, RoHS, CQC

Electrical Characteristics

Wattage consumption	High lumen version: 52W; low lumen version: 34W
Supply voltage	220-240V 50/60Hz
Control interface	ON/OFF

Ordering Information

**REFER TO
LIGHT APPLICATION
FOR CORRECT
ORDERING
CODES AND DETAILS**



Control · Enhance · Preserve

5/8 Hasler Road Osborne Park
Western Australia 6017

Tel: 08 9240 6644

www.lightapplication.com.au

ABN 79 067 791 793

© 2015 Koninklijke Philips N.V. All rights reserved. Philips reserves the right to make changes in specifications and/or to discontinue any product at any time without notice or obligation and will not be liable for any consequences resulting from the use of this publication.



Mercian



The **Mercian** is a high performance wall mounted luminaire designed to achieve wide spacing and features a simple fast-fix mounting system.

OVERVIEW

SPECIAL FEATURES

- Smooth external surface and construction materials are ideal for use in agri-food industries
- Rigid construction prevents luminaire distortion preserving the IP rating over time
- Spacings up to eight times mounting heights

APPLICATIONS

- Typical applications include lighting walk ways and entrance areas, external lighting for industrial premises, educational institutes and hospital/healthcare buildings. It is also ideal for agri-food industries

SPECIFICATIONS & MEASUREMENTS

SPECIFICATIONS

BODY	die-cast aluminium (LM24) pre-treated and powder coated (black)
FIXINGS	corrosion resistant stainless steel screws
LENS	internally prismatic and impact resistant polycarbonate
REFLECTOR	powder coated aluminium (white)
BEAM TYPES	asymmetrical downward throw
CONTROL GEAR	integral
TERMINAL BLOCK	fused
MOUNTING	flush to wall with stainless steel fast-fix bracket
MOUNTING HOLES	outside the gasket line to preserve the IP rating
MAINTENANCE	remove stainless steel fixings to access lamp and control gear

MEASUREMENTS & WEIGHTS

WEIGHT	4.3 kgs Max
WATTAGE	50W 70W

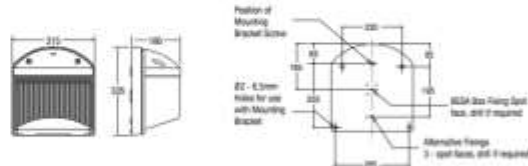

CMH

CODE	DESCRIPTION	LAMP	GEAR	DISTRIBUTION
203610	Mercian CM50/L	50W - CMT50/EX/U	Integral	Asymmetrical Wide Beam Downward Throw
203655	Mercian CM70/L	70W - CMT70/EX/U	Integral	Asymmetrical Wide Beam Downward Throw

Operates on approved high pressure sodium control gear (IEC 60662). All fixtures supplied with lamp and 240V(AUS) / 230V(NZ) 50Hz control gear unless otherwise stated. CMH = Ceramic Metal Halide Lamp. Pictorial is representative only. Specifications may change without notice.

LED

CODE	DESCRIPTION	EXIT (LM)	LED	DISTRIBUTION
203700	Mercian LED 28W Poly Cover IP65 Wall Pack 5700K		28W LED	

PHOTOMETRIC DATA

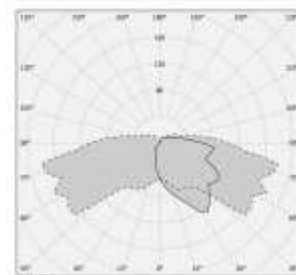

70W EYE Cera Arc EX



FVP4LED-P

CLEVERTRONICS 240V ARGONAUT VANDAL BATTEN



PRODUCT INFORMATION	
Part Number	FVP4LED-P
MIC	AUB04630010003
Description	240V 4ft Argonaut LED Vandal Batten
Construction	Pressure Die-cast, Low Copper Aluminium Alloy Body with Grey Powder Coat Paint Finish. Removable Gear Tray and Replaceable LED Modules.
Mounting	Surface Mount
Dimensions L x W x H	1320mm x 140mm x 120mm
Diffuser	Opal, Impact Resistant Polycarbonate with Secure Access Screws (LSZH)
Driver / Ballast	Tridonic LC 50W 350-1050mA
Lamp(s)	2 x LED module, 4000K natural white, 100,000h [L80/ B20, Ta 40°C], Ra>80
Operating Voltage	240V AC; 50Hz
Power Factor	0.95
Total lumen output	5550 lm @ 123lm/W
Power Consumption	46 Watts
IP Rating	IP66
Operating Temperature	-25°C to 40°C
Impact Rating	IK10
Applicable Standards	AS/NZS3820, CISPR15, AS/NZS60598.1
Compliance Marking (RCM)	

REPLACEMENT PARTS	
PART NUMBER	DESCRIPTION
1330055	LED Driver - LC 50w 350-1050mA, 20-50V
8002699	PCA: LED Strip 5P8S, ALS-50-840-3-01-A

The product details described in this document are current as at the version date of the document. We reserve the right to change product design, specifications or materials (Specifications) as part of our continuous improvement program. Please confirm the applicable Specifications at the time of placing your order



CLEVERTRONICS L10 VANDALPROOF BATTEN DATA SHEET



PRODUCT INFORMATION	
Catalogue Number	LVP4LED-M-P
Description	L10 Optimum 4ft LED Vandalproof Batten with Battery POD and LED modules/light engines
Construction	Pressure die-cast, low copper aluminium alloy body with grey powder coat paint finish. Removable gear tray and replaceable LED modules. Battery POD at one end (retains through-conduit/wiring capability even with the POD)
Mounting	Surface mount
Dimensions L x W x H	1400mm x 140mm x 120mm (including battery POD)
Operating Mode	Maintained
Testing System	N/A - Manual test switch
Battery	Lithium Nanophosphate, 6.6V 2500mAh
Charging Method	Intelligent Current Limited Constant Voltage
Diffuser	Opal, Impact Resistant Polycarbonate with Secure Access Screws
LED Driver	SELV LED driver >50,000hrs (<10% failure), 220-240 V ±10%
Lamp(s)	2 x LED module, 4000K natural white, 50,000h [L80/ B20, Ta 40°C], Ra>80
Operating Voltage	240V AC; 50Hz
Power Factor	> 0.9
Total lumen output	5300 lm @ 115lm/W (118lm/W non-Emergency version)
Power Consumption	46Watts (Lamps ON), 1 Watt (Lamps OFF)
IP Rating	IP66
Operating Temperature	0°C to 40°C
AS2293 Classification	C0 = D100, C90 = D63, C180 = D100, C270 = D50
Impact Rating	IK10

REPLACEMENT PARTS	
PART NUMBER	DESCRIPTION
1530260	BATT:L10 6.6V 2500mAh.200mm lead.SBS.
1330125	LED Driver - 2x28.5w 2x500-700mA, Dimm
8002680	PCA:60 LED Strip 600mm, WU-M-481-HB-840
LCPLED-56V80C	LED Power Pack, 56V 80mA, 6.6V 2.5Ah,L10



Version: September 2017-I
www.clevertronics.com.au



© Clevertronics Pty Ltd. All rights reserved.
 Refer to DM for current version



FVP2LED-P

CLEVERTRONICS 240V ARGONAUT VANDAL BATTEN



PRODUCT INFORMATION

Catalogue Number	FVP2LED-P
Description	240V 2ft Argonaut LED Vandal Batten
Construction	Pressure Die-cast, Low Copper Aluminium Alloy Body with Grey Powder Coat Paint Finish. Removable Gear Tray and Replaceable LED Modules.
Mounting	Surface Mount
Dimensions L x W x H	700mm x 140mm x 120mm
Weight	2.4kg
Diffuser	Opal, Impact Resistant Polycarbonate with Secure Access Screws
Driver / Ballast	Tridonic LC 50W 350-1050mA
Lamp(s)	LED module, 4000K natural white, 50,000h [L80/ B20, Ta 40°C], Ra>80
Operating Voltage	240V AC; 50Hz
Power Factor	> 0.9
Total lumen output	2500 lm @ 114lm/W
Power Consumption	22 Watts
IP Rating	IP66
Operating Temperature	0°C to 40°C
Impact Rating	IK10

REPLACEMENT PARTS

PART NUMBER	DESCRIPTION
1330055	LED Driver - LC 50w 1050mA, fleC Ip EXC
8002699	PCA: LED Strip 5P8S, ALS-50-840-3-01-A

**240V
Non-Emergency**

CLEVERTRONICS L10 ARGONAUT VANDAL BATTEN



PRODUCT INFORMATION

Catalogue Number	LVP2LEDM-P
MIC	AUB01330020001
Description	L10 Optimum 2ft Argonaut LED Vandal Batten with Battery POD and LED Modules/Light Engines
Construction	Pressure Die-cast, Low Copper Aluminium Alloy Body with Grey Powder Coat Paint Finish. Removable Gear Tray and Replaceable LED Modules. Battery POD at one end. (Retains Through-Conduit/Wiring Capability even with the POD)
Mounting	Surface Mount
Dimensions L x W x H	790mm x 140mm x 120mm (including battery POD)
Operating Mode	Maintained
Testing System	Clevertest Plus Enabled (Not activated by default)
Battery	Lithium Nanophosphate, 6.6V 2500mAh
Charging Method	Intelligent Current Limited Constant Voltage
Diffuser	Opal, Impact Resistant Polycarbonate with Secure Access Screws, LSZH
Driver / Ballast	Tridonic LC 50W 350-1050mA
Lamp(s)	1 x LED module, 4000K natural white, 100,000h [L80/ B20, Ta 40°C], Ra>80
Operating Voltage	240V AC; 50Hz
Power Factor	0.95
Total lumen output	2529 lm @109lm/W (based on non-emergency version @23W)
Power Consumption	27W (MAX charging-Lamp ON), 23W (Standby Lamp ON), 1.3W (Standby Lamp OFF)
IP Rating	IP66
Operating Temperature	0°C to 40°C
AS2293 Classification	C ₀ =D63 C ₉₀ =D32
Impact Rating	IK10

REPLACEMENT PARTS

PART NUMBER	DESCRIPTION
1530260	BATT:L10 6.6V 2500mA.SBS. (2)
1330055	LED Driver - LC 50w 1050mA, fleC Ip EXC
8002699	PCA: LED Strip 5P8S, ALS-50-840-3-01-A
LCPLED-38V120C-CKIT-ZW	LED Power Pack, 38V 120mA, 6.6V 2.5Ah,L10

The product details described in this document are current as at the version date of the document. We reserve the right to change product design, specifications or materials (Specifications) as part of our continuous improvement program. Please confirm the applicable Specifications at the time of placing your order

Appendix C: Typical Lighting Models⁹

C.1. Outdoor Yard Lighting

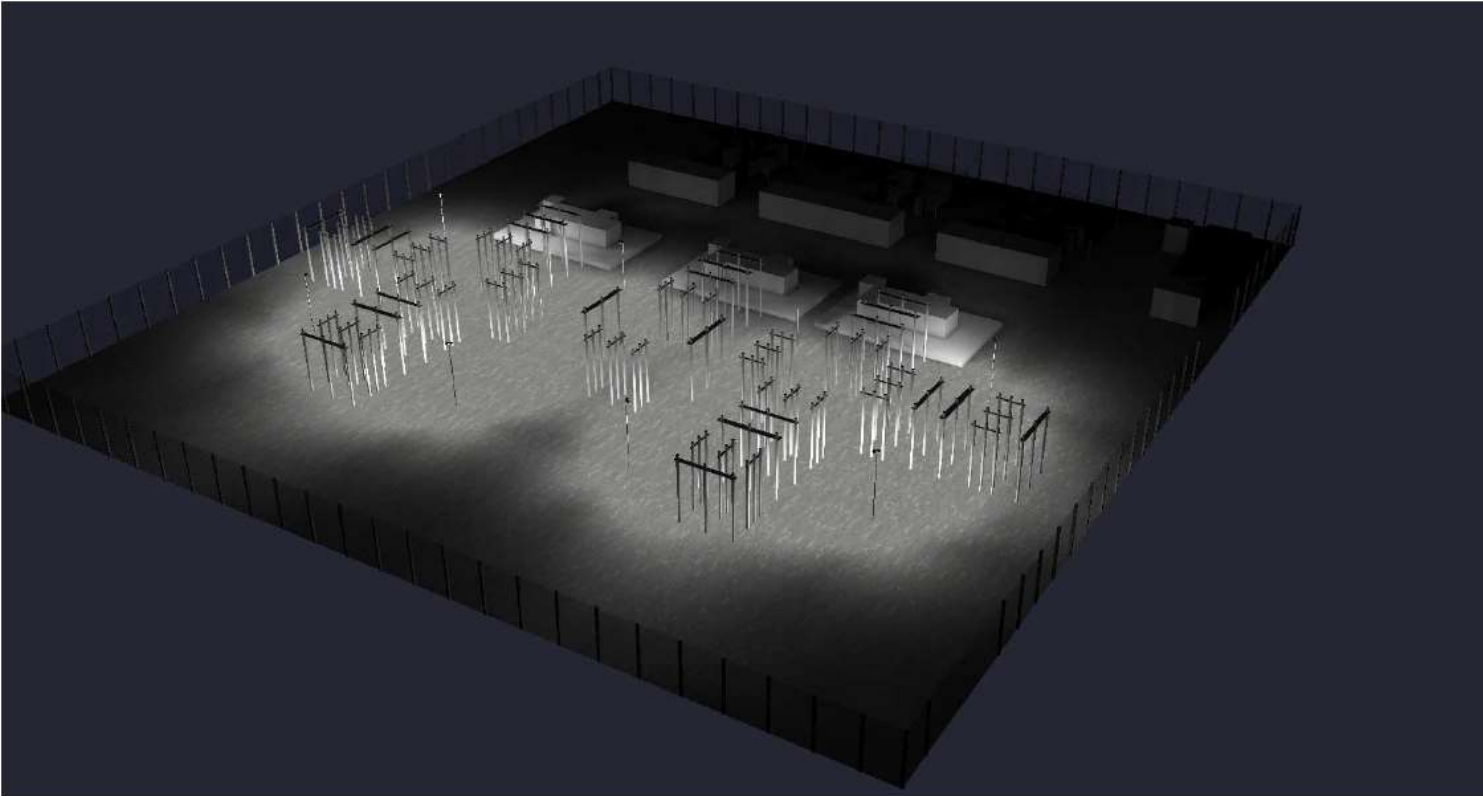

⁹ See Western Power Internal Document

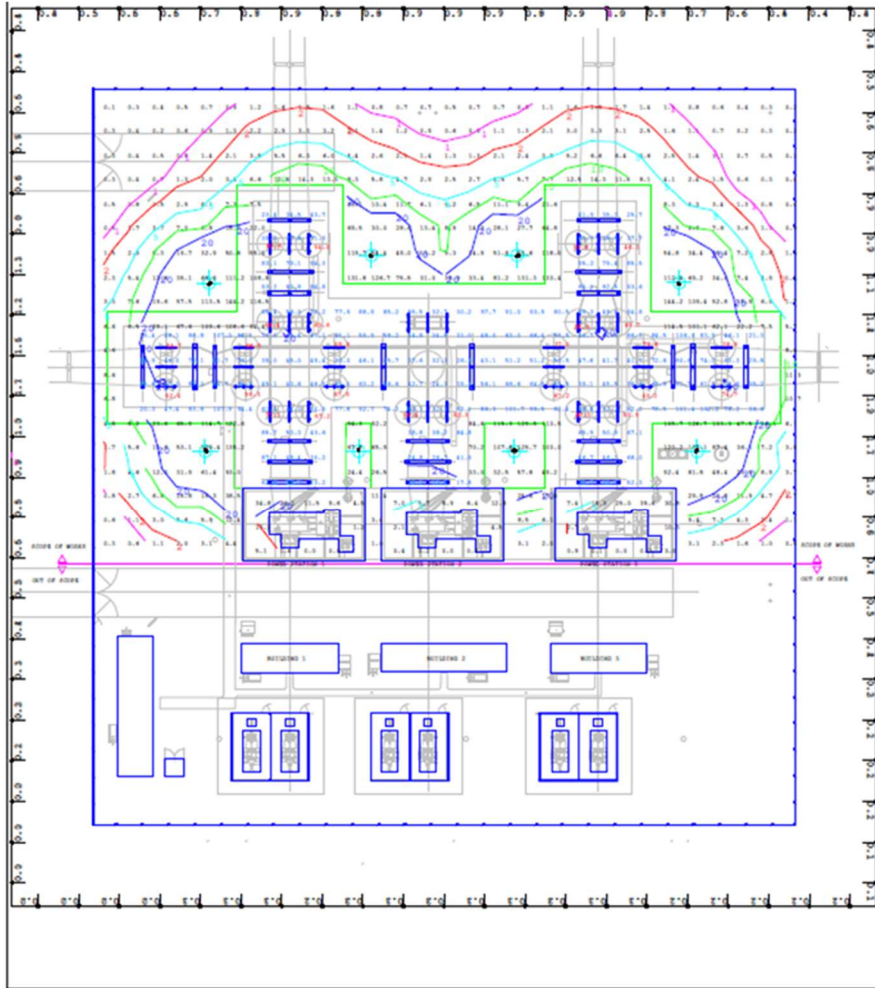

Design Notes

1. This Preliminary Lighting Calculation is based on the information provided by Western Power.
2. Design Intent:
 Achieve 50 Lux Average within the Red Zone
 Achieve 20 Lux Average within the Blue Zone
 Achieve 5 Lux Average in surrounding Site
 Luminaires to be located 3m from Green Zone for Grass Foli Maintenance
 All poles are 6m
 Luminaires to have same manufacture and optic for Maintenance and Sourcing Feasibility
3. All Site areas below the 50W Demarcation are considered illuminated by the Building Lighting
4. Lighting calculations are based on initial lumens with maintenance factor (LMF) as shown 0.70.
5. Obstructions have been included in this lighting design.
6. Lighting calculations are subject to the accuracies & tolerances in accordance with AS/NZS 3527.1:1999 & AS/NZS 3527.2:1999..
7. Calculation values may differ to onsite results due to environmental variations such as actual luminaire positioning, surface reflectance & finishes, supply voltage, local luminaire ambient temperature, obstructions / furniture etc. These results are also subject to normally accepted photometric tolerances, and calculation/program uncertainties.

Luminaire Schedule

Symbol	Qty	Label	Arrangement	Total Lamp Lumens	LLF
☐	16	PureLED Luminant120	SINGLE	17168	0.700

Calculation Summary

Label	CalcType	Units	Avg	Max	Min	Min/Max	Max/Avg
Blue Zone	Illuminance	Lux	56.47	107.9	11.5	0.11	1.91
Obtrusive Light East	Obtrusive Light	Lux	0.66	2.0	0.1	0.05	3.03
Obtrusive Light North	Obtrusive Light	Lux	0.68	1.0	0.3	0.30	1.47
Obtrusive Light South	Obtrusive Light	Lux	0.17	0.3	0.0	0.00	1.76
Obtrusive Light West	Obtrusive Light	Lux	0.61	1.7	0.0	0.00	3.79
Power Station 1	Illuminance	Lux	9.79	34.8	0.0	0.00	3.55
Power Station 2	Illuminance	Lux	4.07	12.6	0.0	0.00	3.10
Power Station 3	Illuminance	Lux	10.93	35.6	0.0	0.00	3.26
Red Zone	Illuminance	Lux	60.31	94.0	37.0	0.39	1.56
Site	Illuminance	Lux	24.51	144.2	0.1	0.00	5.88

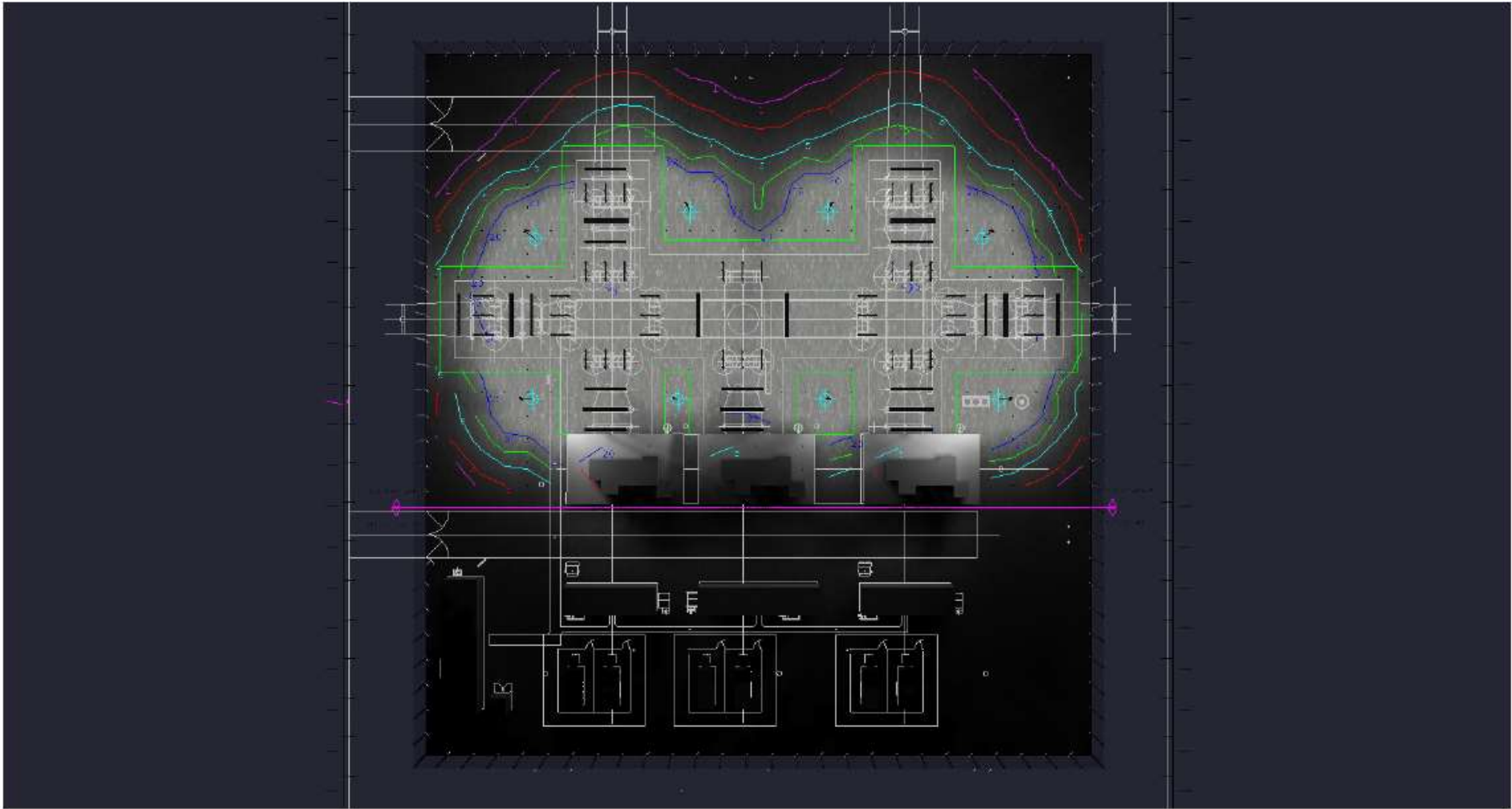

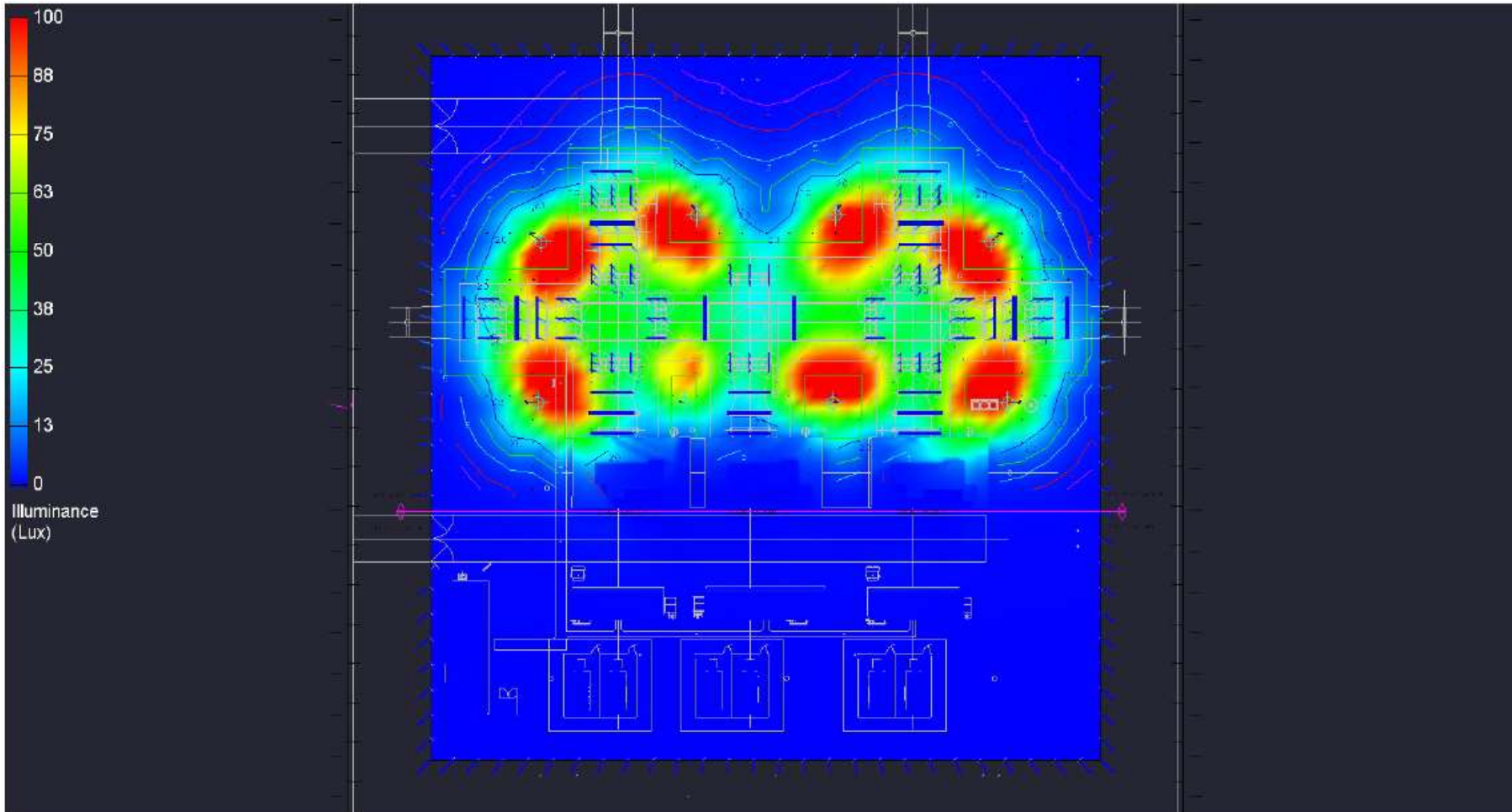

Uncontrolled document when printed
Refer to DM for current version

C.2. Security Lighting

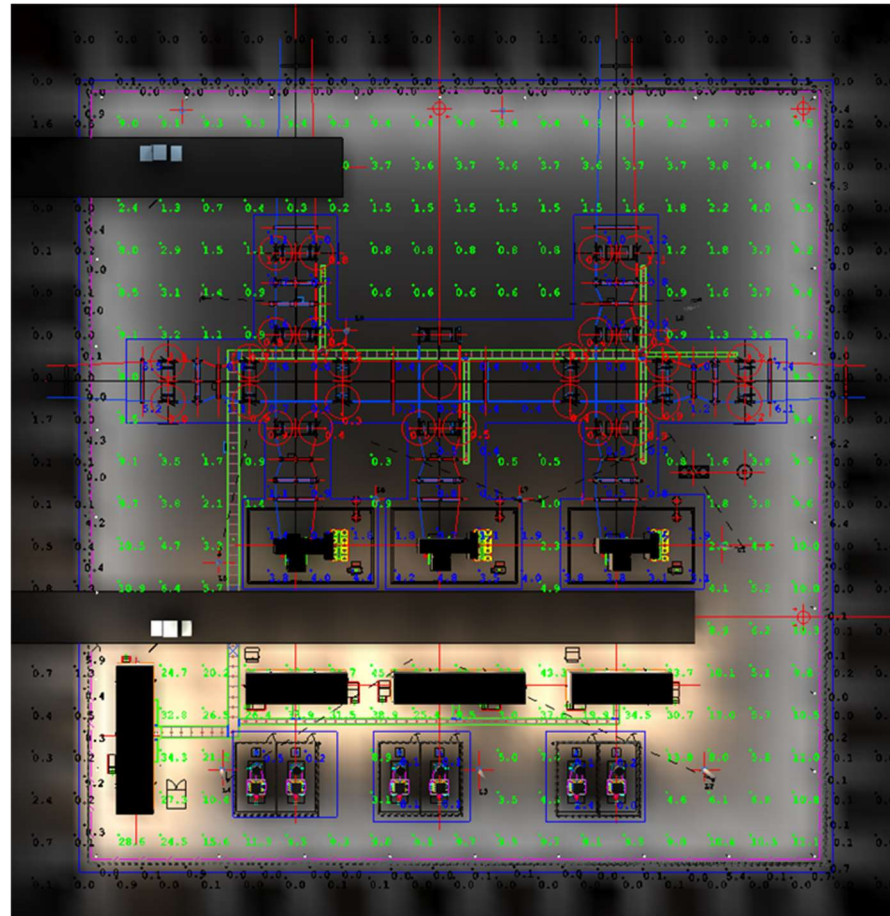
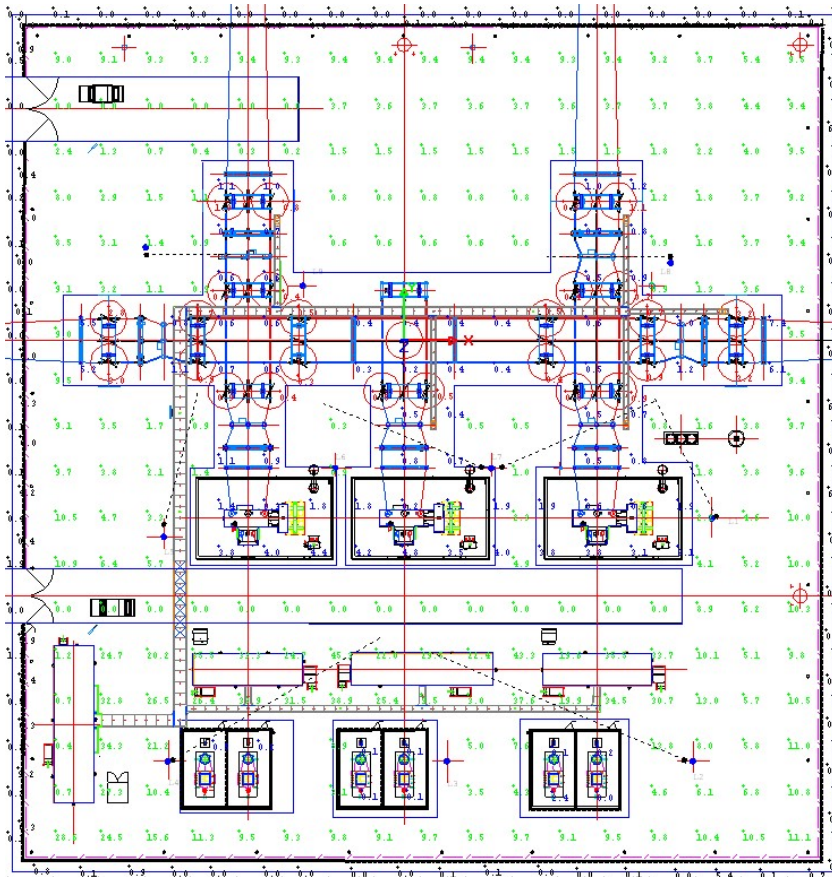

C.3. Backup Lighting

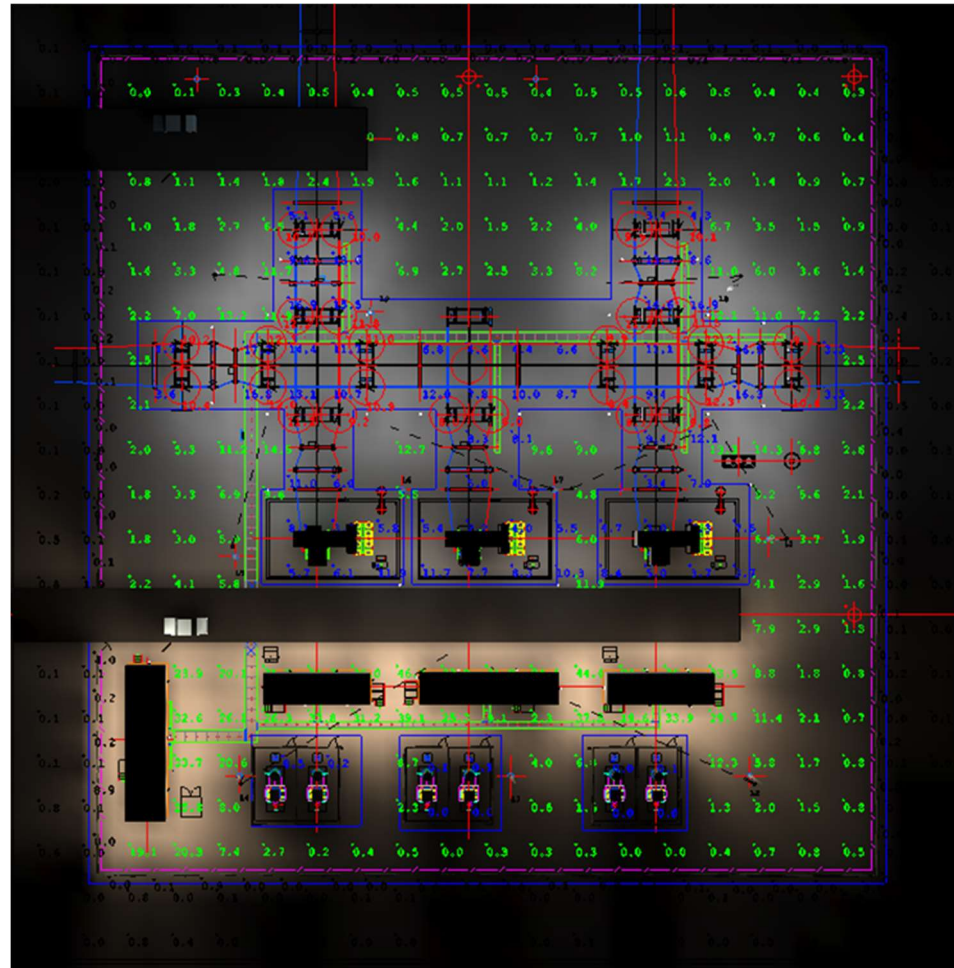
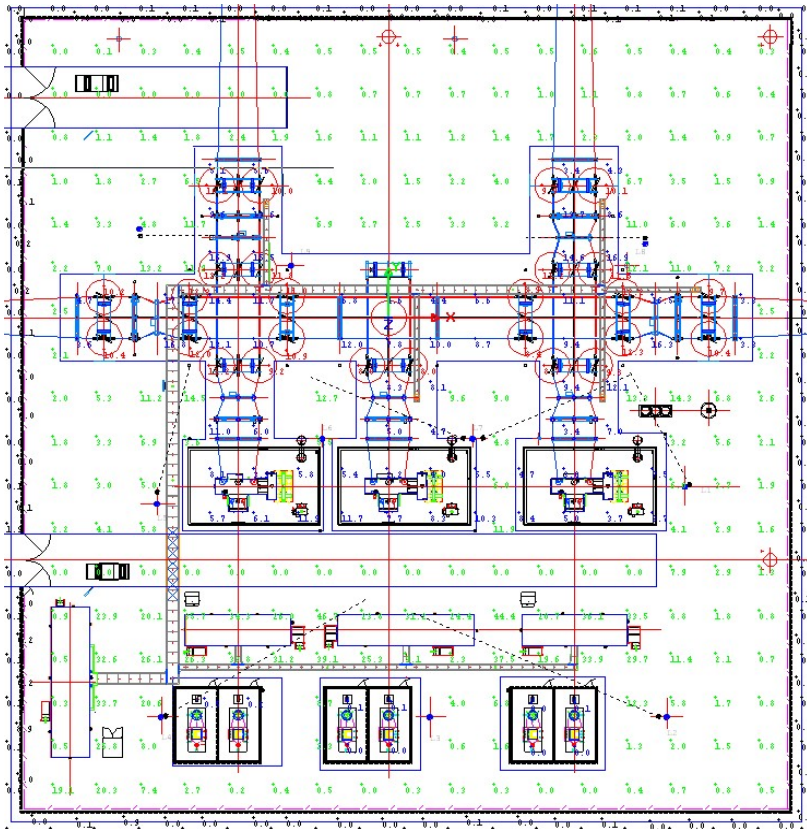

Uncontrolled document when printed
Refer to DM for current version

C.4. External Switch/Relay Room Lighting

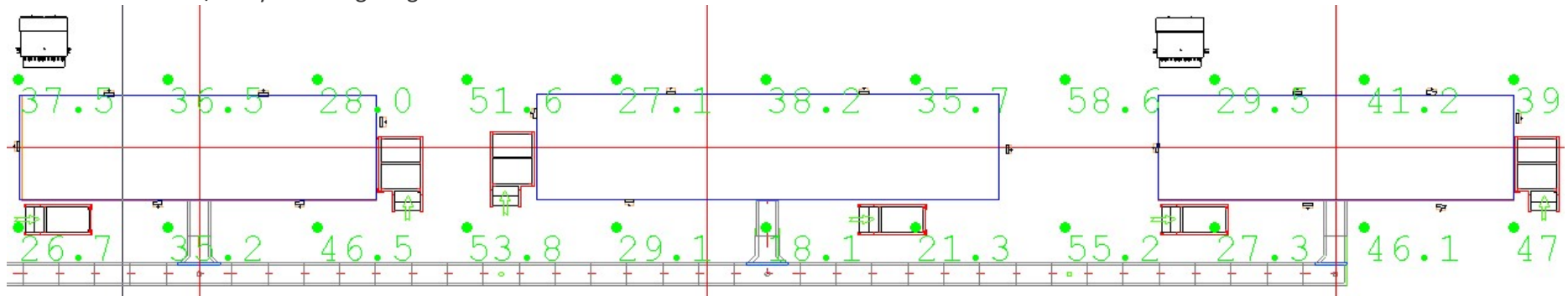

C.5. Internal Switch/Relay Room Lighting – Upstairs

Standard Lighting: Showing 6 ceiling mounted lights 3 off FVP4LED-P and 3 off LVP4LEDM-P (emergency) in normal operating mode

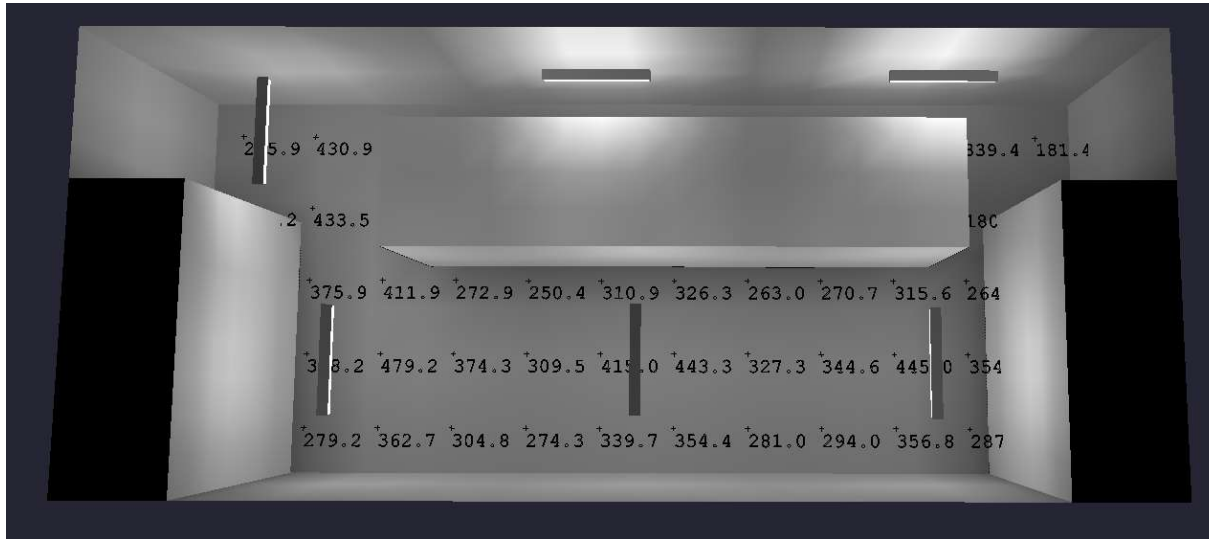
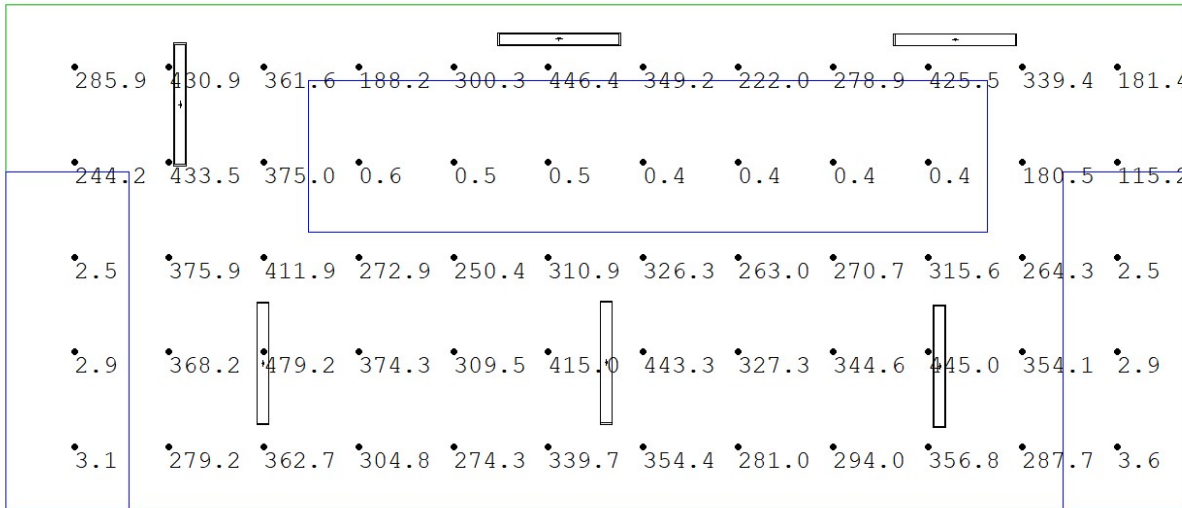

Uncontrolled document when printed
Refer to DM for current version

Emergency Lighting: Showing 3 ceiling mounted emergency lights LVP4LEDM-P in emergency operating mode

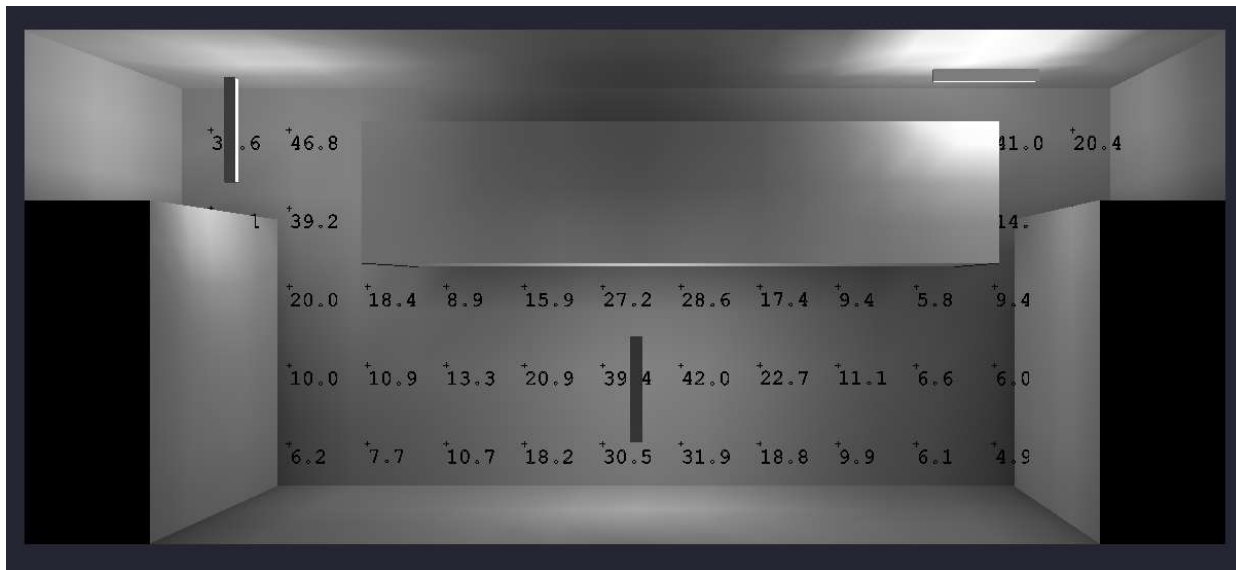
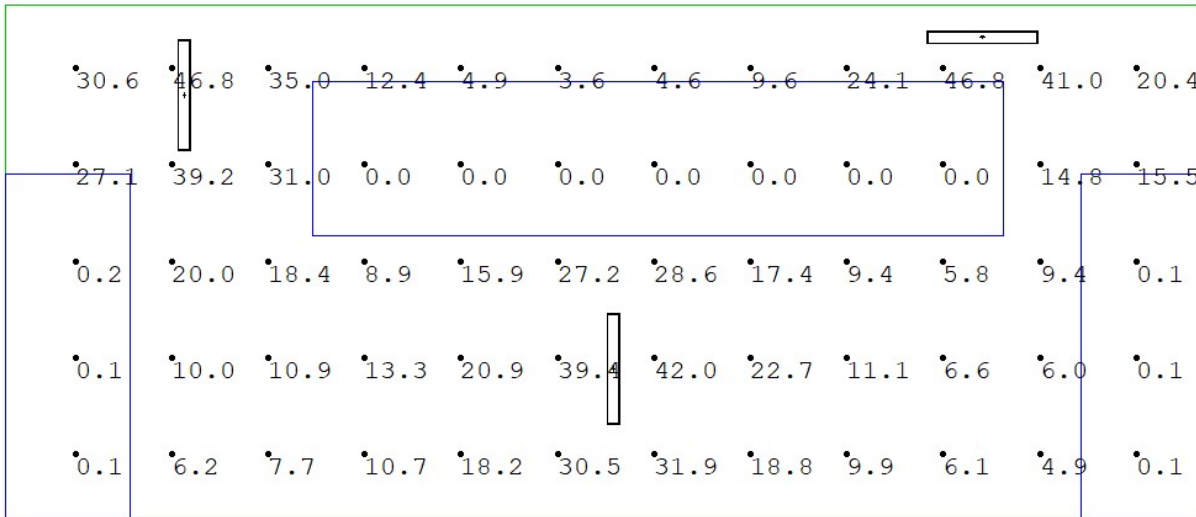

C.6. Internal Switch/Relay Room Lighting – Basement

Standard lighting: Showing 6 wall mounted lights 3 off FVP2LED-P and 3 off LVP2LEDM-P (emergency) and 2 ceiling mounted emergency lights LVP4LEDM-P above stairs, all in normal operating mode

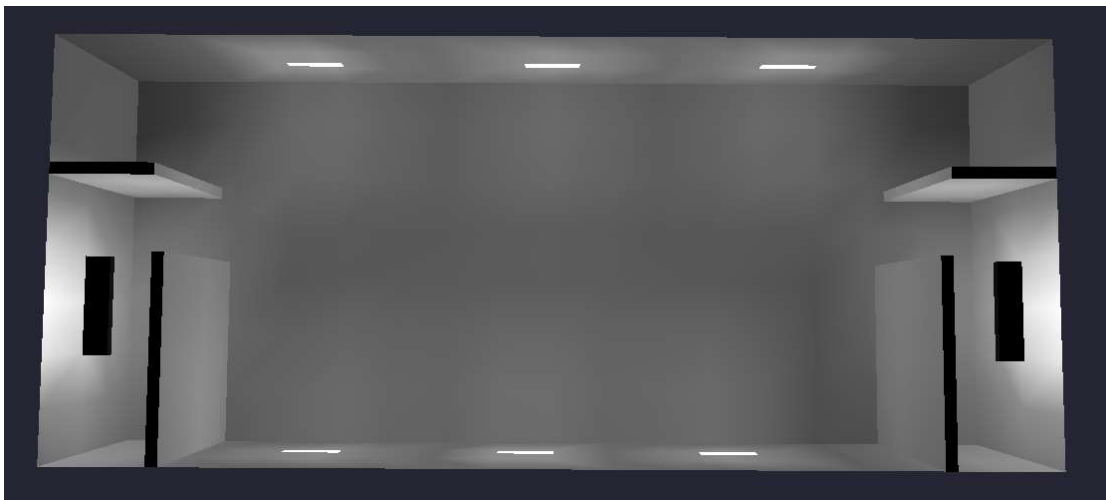
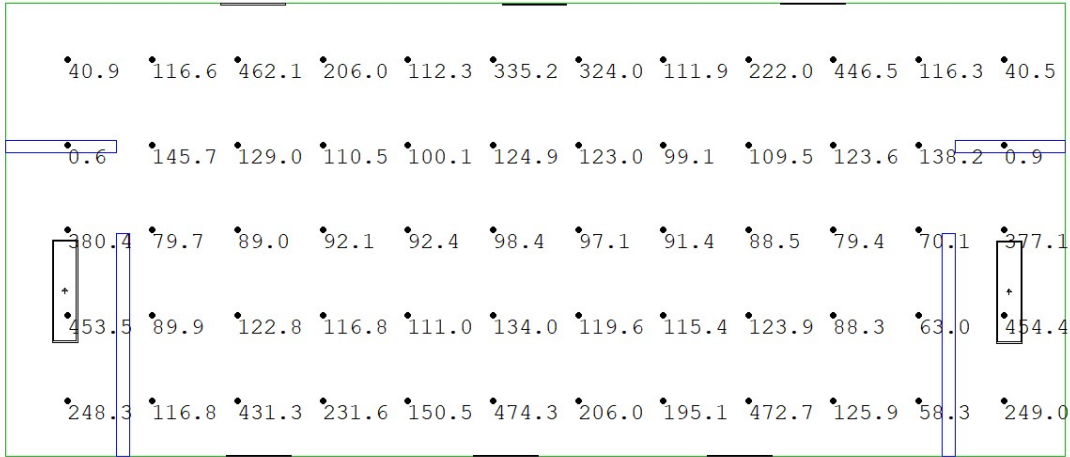

Uncontrolled document when printed
Refer to DM for current version

Emergency Lighting: Showing 3 wall mounted emergency lights (LVP2LEDM-P) and 2 ceiling mounted emergency lights (LVP4LEDM-P) above stairs in emergency operating mode

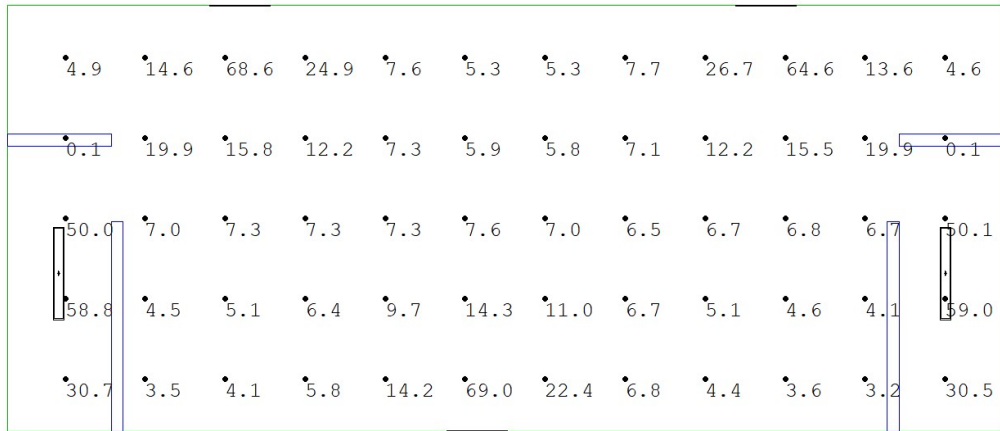

Appendix D: Approval Record and Document Control¹⁰

¹⁰ See Western Power Internal Document